

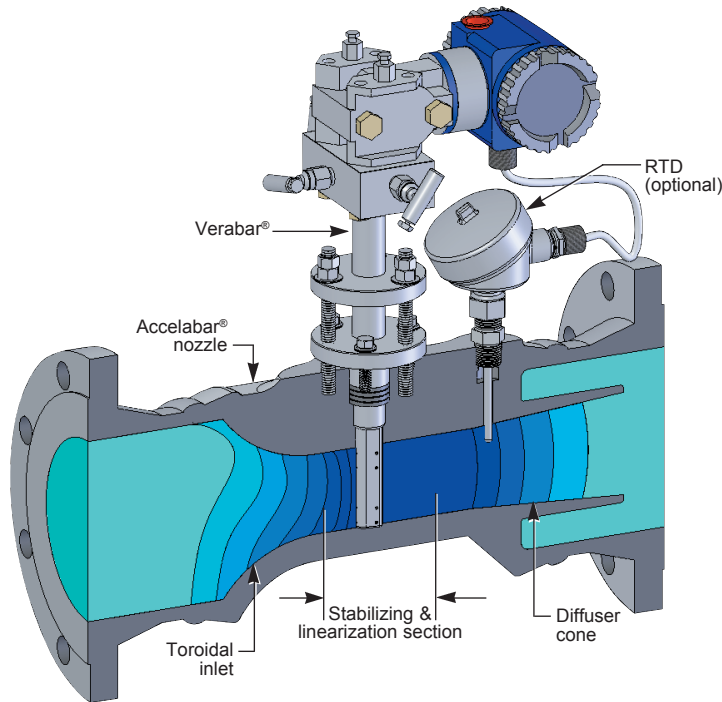

**VERIS ACCELABAR®**  
SUPERIOR FLOW MEASUREMENT ACCURACY

## The Unique Accelabar® Flow Meter

The Accelabar® is a new and unique flow meter that combines two differential pressure technologies to produce operating ranges never before attainable in a single flow meter. It is capable of generating high differential pressures for measuring gas, liquids and steam at turndowns previously unattainable—with no straight run requirements.



## How the Accelabar® Works

The Accelabar® consists of a unique toroidal nozzle design and a Verabar® averaging pitot. The nozzle has a patented straight run “settling distance” that accelerates, linearizes and stabilizes the velocity profile sensed by the Verabar®. The Verabar® located within the nozzle accurately measures and significantly increases the differential pressure output to increase the operating range (turndown). The Accelabar® has a constant flow coefficient and produces an accuracy of up to  $\pm 0.50\%$ .

**Other manufacturers claim high accuracy, but over a limited turndown.**

## No Straight Run Required

The Accelabar® can be used in extremely limited straight run piping configurations. The straight run is integral to the meter. The stabilization and linearization of the velocity profile within the throat of the nozzle eliminates the need for any upstream run.

US Patent No. 6,868,741 B2 and various foreign patents pending.

## Engineering Specifications

- Low velocity flow rates
- High accuracy: to  $\pm 0.50\%$
- Repeatability:  $\pm 0.050\%$
- Verified flow coefficients
- No calibration required
- Extended turndown
- No straight run requirements
- Low permanent pressure loss
- Mass or volumetric flow



## Actual Application (see data on page 3)

<b>Application:</b>	3" Sch 40 Natural Gas
<b>Operating Pressure/ Temperature:</b>	50 PSIG/70°F
<b>Max/Min Flow Rate:</b>	60,000 SCFH/1,000 SCFH
<b>Flow Turndown:</b>	60:1
<b>Straight Run:</b>	0"

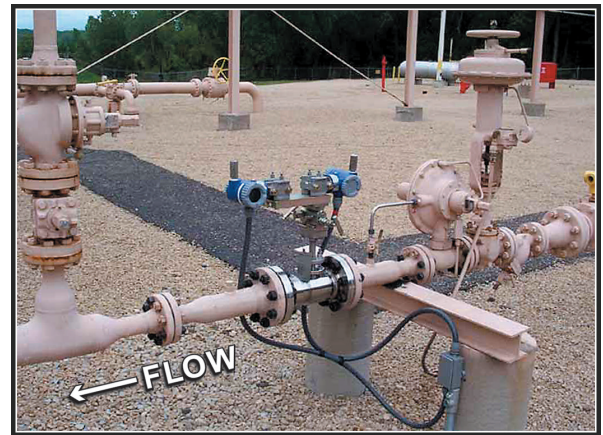

## Verabar® Provides the Accuracy

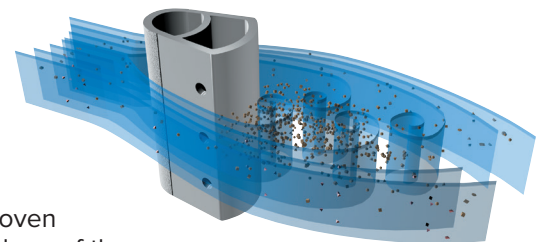

The proven technology of the Verabar® makes the Accelabar® work. It accurately measures the flow rate within the nozzle. Its unique bullet shape, constant flow coefficient, solid one-piece construction, non-clog design and signal stability make it the only design capable of producing the overall performance.

# VERIS Accelabar® ...Performance Characteristics

## Comparative Analysis vs. Other Flow Meters

The Accelabar® fills the need not presently being filled by other flow meters for applications that:

- Do not have sufficient velocity to produce a readable signal or sufficient turndown
- Require the highest accuracy over an extended range
- Have little or no straight run piping before the meter

The Accelabar® performance characteristics far exceed those of other DP meters, vortex meters and many other flow meters.

These charts show the actual performance characteristics of the Accelabar® versus other flow meters based on the following flow conditions:

Flow Conditions	
Fluid	Natural Gas
Pipe Size	3" Sch 40
Max Flow	60,000 SCFH
SG	0.6
Pressure	50 psig
Temperature	70°F
Pipe Line Velocity	74 ft/sec

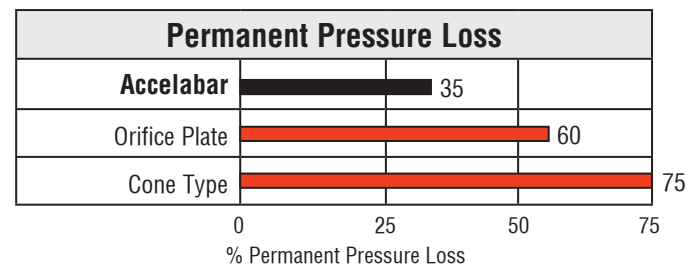
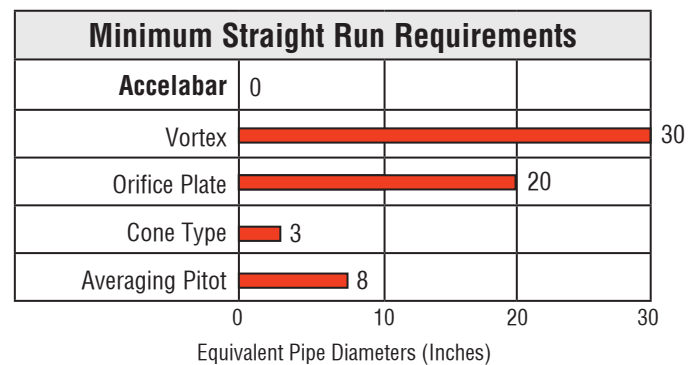
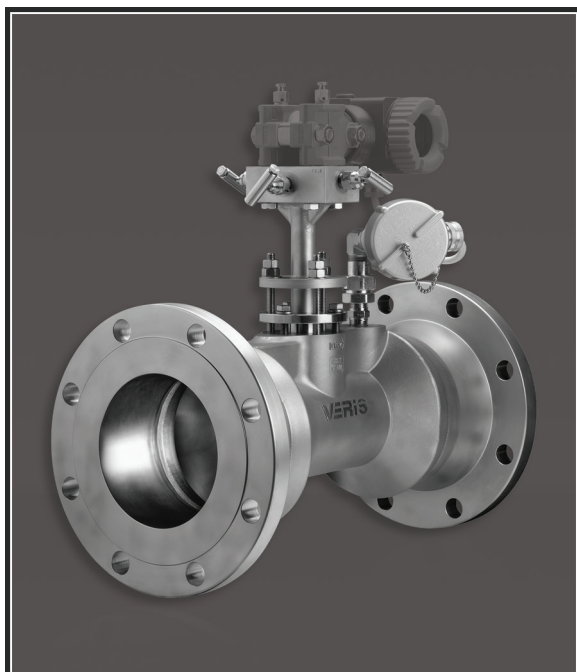
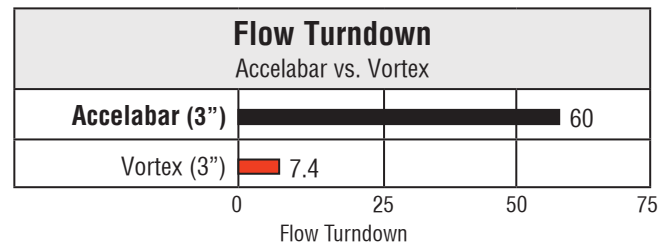
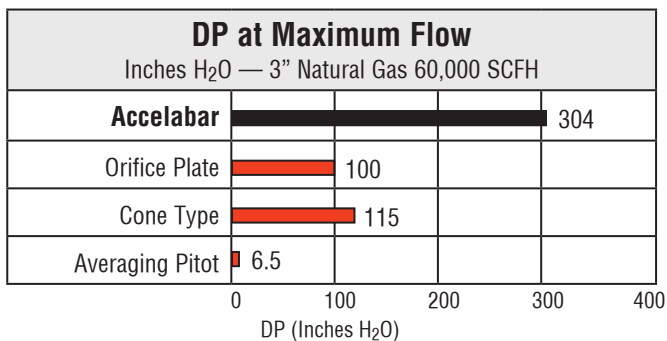
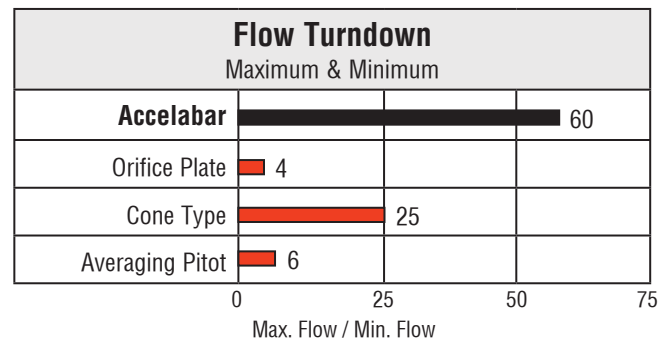
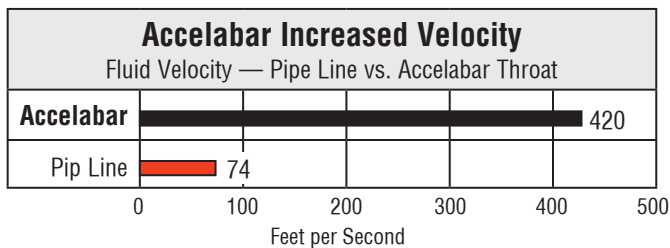

## Verified Accuracy and Flow Coefficients

Empirical TEST DATA from independent laboratories verified an analytical model and flow coefficients as constant and independent of Reynolds Number, and within +/- 0.5% of the predicted value over an extended turndown in flow.

**This eliminates the need for calibration.**

## The Proof Is In The Data

Many flow meters claim high accuracy and rangeability or turndown. However, few manufacturers define their limitations and even fewer can support it with actual test data. The tests below show the performance capabilities of the Accelabar®.

## Tested at CEESI (an independent Flow Lab)

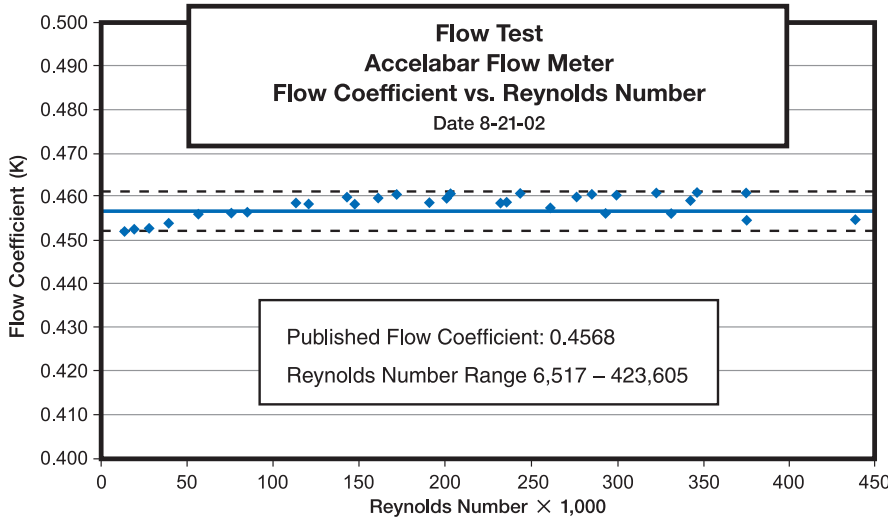

### Results

The Accelabar® produced a DP of 306" H<sub>2</sub>O at 145 ACFM. An accuracy of +/- 0.75% over an extended Reynolds number range. No other flow meter is capable of these operating ranges.

\*Independent, NIST traceable tests were performed as follows:

- Air tests in 3", 4", 6" and 12" pipes
  - NIST traceable water tests
  - Large turndown natural gas testing
  - Short straight-run testing
- Consult factory for a copy of certified tests.

## No Straight Run Test Comparison

### Test Specifications

The Accelabar® was tested immediately downstream of a valve, tee and expander assembly with no straight run upstream.

### Results

The short run test plotted with the standard straight run test verifies there is no shift in the flow coefficient.

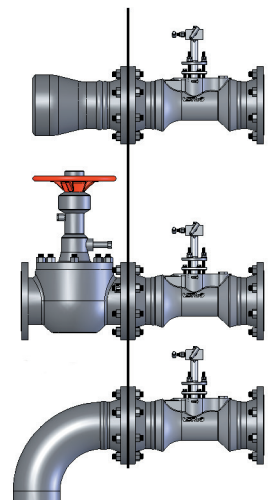
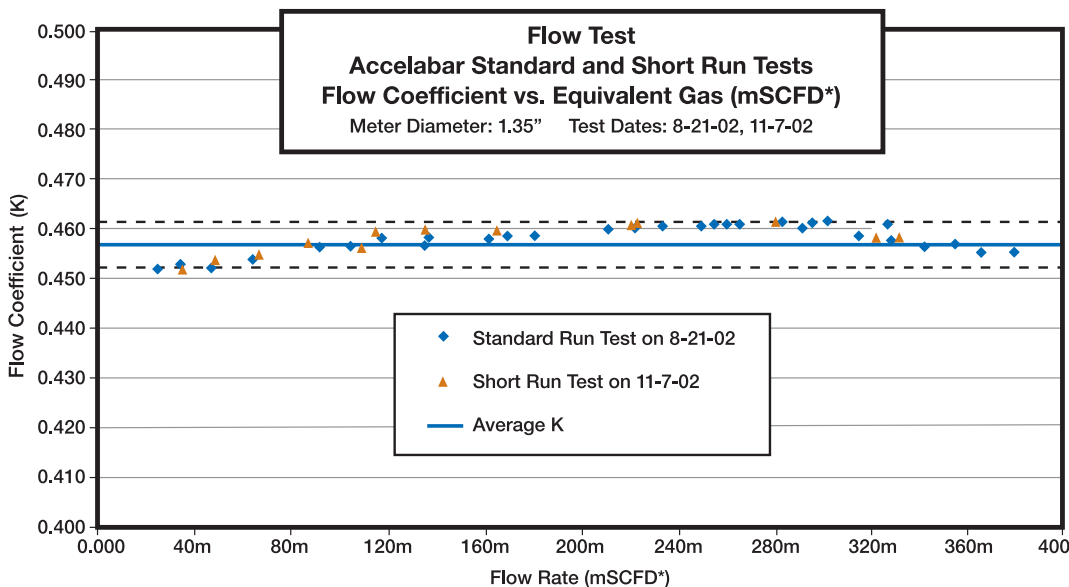



# VERIS Accelabar® ...Models and Specifications

## Ready to Install

The Accelabar® is a complete flow meter ready to install. It comes complete with single or dual transmitters depending on the turndown requirements.

An optional RTD is supplied in a Thermowell for dynamic compensation (required for use with multivariable transmitter).

## Specifications

Accuracy	Repeatability	Sensor, Body & Flange
to ± 0.50%	±0.050%	316SS

## Accelabar® Model Selection

- Furnish your flowing conditions. A flow calculation is required to determine the DP and verification of the operating limits.
  - Each meter size has a standard beta ratio sized for the optimal operating range.
  - The maximum operating limits are determined by the Accelabar® flow calculation.
- If your flowing conditions exceed the operating limits, a larger or smaller model (meter size) must be selected.

## AF Flanged Model

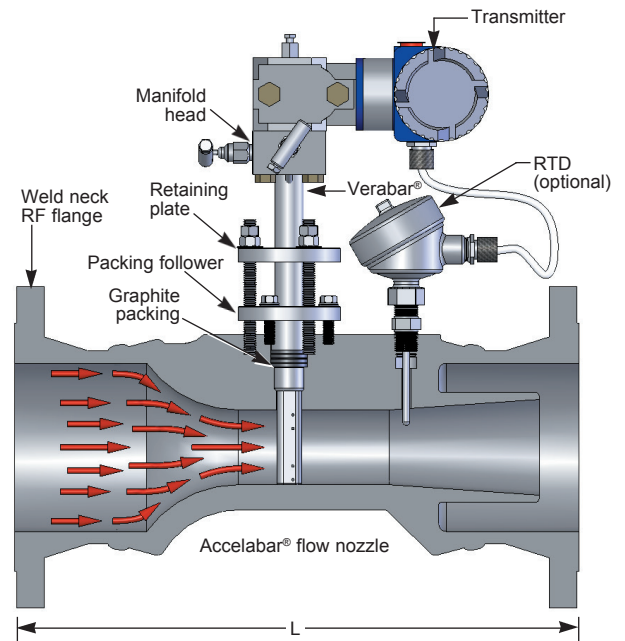

## Flowing Conditions

General Data	Fluid Parameters	Maximum	Normal	Minimum	Units
Tag number	Flow Rate				
Pipe size & schedule or exact ID & wall thickness	Pressure				
	Temperature				
Fluid name:	Density*				

\*Density is not required for steam applications.











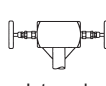

## Chart A

Meter Size	Verabar Sensor	Face to Face "L"							
		Class 150#	Class 300#	Class 600#	PN10	PN16	PN40	PN63	PN100
2" (DN50)	-05 1/2"	8.75" (222.3mm)	9.38" (238.2mm)	10.13" (257.1mm)	11.54" (293.2mm)	11.54" (293.2mm)	11.78" (296.2mm)	12.88" (327.2mm)	13.35" (339.2mm)
3" (DN80)	-05 1/2"	13.78" (350.0mm)	14.53" (369.0mm)	15.28" (388.1mm)	12.31" (312.8mm)	12.31" (312.8mm)	12.94" (328.8mm)	14.04" (356.8mm)	14.52" (368.8mm)
4" (DN100)	-05 1/2"	15.15" (384.8mm)	15.90" (403.9mm)	17.65" (448.3mm)	13.34" (338.9mm)	13.34" (338.9mm)	14.36" (364.9mm)	15.39" (390.9mm)	16.34" (414.9mm)
6" (DN150)	-10 1/2"	19.15" (486.4mm)	19.90" (505.5mm)	21.90" (556.3mm)	16.58" (421.1mm)	16.58" (421.1mm)	18.15" (461.1mm)	19.73" (501.1mm)	21.30" (541.1mm)
8" (DN200)	-10 1/2"	21.40" (543.6mm)	22.15" (562.6mm)	24.40" (619.7mm)	18.38" (466.9mm)	18.38" (466.9mm)	20.42" (518.9mm)	22.16" (562.9mm)	23.74" (602.9mm)
10" (DN250)	-10 1/2"	23.15" (588.0mm)	24.40" (619.8mm)	27.65" (702.31mm)	20.60" (523.3mm)	20.76" (527.3mm)	23.51" (597.3mm)	25.09" (637.3mm)	27.61" (701.3mm)
12" (DN300)	-10 1/2"	26.17" (664.7mm)	27.78" (705.6mm)	29.67" (753.6mm)	22.62" (574.6mm)	23.41" (594.6mm)	26.32" (668.6mm)	28.29" (718.6mm)	30.65" (778.6mm)

\*Face to face dimensions nominal. Custom lengths available.

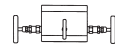
Designs, materials, weights and performance ratings are approximate and subject to change without notice. Visit [armstronginternational.com/veris](http://armstronginternational.com/veris) for up-to-date information.

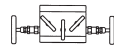
# VERIS Accelabar® ...Ordering Information

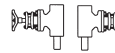
<b>Model</b>	<b>Accelabar 316SS</b>										
<b>AFS</b>	Flanged Connections										
<b>ABS</b>	Bevel for Weld										
<b>ATS</b>	MNPT Threaded Ends (2" meter only)										
<b>User Mating Pipe Size and Schedule or Exact ID and Wall Thickness</b>											
<b>Code</b>	<b>User Mating Flange (Model AFS Only)</b>										
<b>150</b>	150# ANSI Class 275 psig @ 100°F, 80 psig @ 800°F (19 Bars @ 38°C, 5.5 Bars @ 426°C)										
<b>300</b>	300# ANSI Class 720 psig @ 100°F, 330 psig @ 800°F (49.6 Bars @ 38°C, 22.8 Bars @ 426°C)										
<b>600</b>	600# ANSI Class 1440 psig @ 100°F, 660 psig @ 800°F (99.3 Bars @ 38°C, 45.5 Bars @ 426°C)										
If other than ANSI, specify Standard (DIN, JIS) Size and Rating											
<b>Code</b>	<b>Flange Material</b>										
<b>C</b>	Carbon Steel										
<b>S</b>	Stainless Steel										
<b>Accelabar Meter Size</b>											
<i>Important: If the selected meter size is larger or smaller than the user's mating pipe and flange, expanders or reducers are required. Consult the factory for price and delivery.</i>											
											
<b>2"</b>	<b>3"</b>	<b>4"</b>	<b>6"</b>	<b>8"</b>	<b>10"</b>	<b>12"</b>					
<b>(50mm)</b>	<b>(75mm)</b>	<b>(100mm)</b>	<b>(150mm)</b>	<b>(200mm)</b>	<b>(250mm)</b>	<b>(300mm)</b>					
<b>Code</b>	<b>Verabar Size</b>										
<b>05</b>	7/16" (11mm)										
<b>10</b>	7/8" (22mm)										
<b>Code</b>	<b>Pipe Orientation</b>										
<b>H</b>	Horizontal										
<b>V</b>	Vertical										
<b>Instrument Head Connections (Select Remote or Direct Mount Transmitter—Sold Separately)</b>											
 <b>Direct Mount Transmitter</b> (Flanged 450°F/232°C Max.)					 <b>Remote Mount Transmitter</b> (1/2" NPT)						
Manifold		Transmount		Valve		Regular		Parallel			
											
<b>M</b>		<b>F</b>		<b>T</b>		<b>R</b>		<b>P</b>			
<b>Manifolds (Optional)</b>					<b>Instrument Valves (Optional)</b>						
 <b>Direct Mount</b>					 <b>Remote Mount</b>						
3-Valve			5-Valve			Needle		Gate			
											
Soft Seat		Hard Seat		Soft Seat		Hard Seat		1/2" NPT		1/2" NPT	
<b>F3SC (CS)</b>		<b>F3HC (CS)</b>		<b>F5SC (CS)</b>		<b>F5HC (CS)</b>		<b>C2NC (CS)</b>		<b>C2GC (CS)</b>	
<b>F3SS (SS)</b>		<b>F3HS (SS)</b>		<b>F5SS (SS)</b>		<b>F5HS (SS)</b>		<b>C2NS (SS)</b>		<b>C2GS (SS)</b>	
<b>Code</b>	<b>RTD in Thermowell</b>										
<b>H1</b>	Hazardous Location, Class 1 Div 1, Explosion Proof										
<b>H2</b>	Hazardous Location, Class 1 Div 2, Non-Incendive Wiring										
<b>HT</b>	High Temperature (500°F to 900°F, 260°C to 482°C)										
<b>NH</b>	Non-Hazardous Location										
<b>Code</b>	<b>Connection Cable to Transmitter (Direct Mount Only)</b>										
<b>XP</b>	Explosion Proof (hazardous locations)										
<b>N4</b>	NEMA 4										
<b>AFS</b>	<b>6" Sch40</b>	<b>150</b>	<b>SS</b>	<b>4"</b>	<b>05</b>	<b>H</b>	<b>R</b>	<b>C2NC</b>	<b>H2</b>	<b>XP</b>	<b>For Transmitter Selection, see Page 7.</b>

# VERIS Accelabar® ...The Best Choice in Flow Meters

## Transmitter Selection

**Accelabar® accuracy is percent of rate.** The Accelabar® maintains a constant flow coefficient over a wide range of flow rates and differential pressures.

**DP transmitter accuracy is percent of scale.** While most Accelabar® installations are equipped with one DP transmitter, some applications requiring superior accuracy over an extreme DP turndown may require a dual DP transmitter installation.

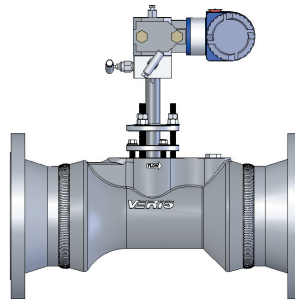

**Single Transmitter**

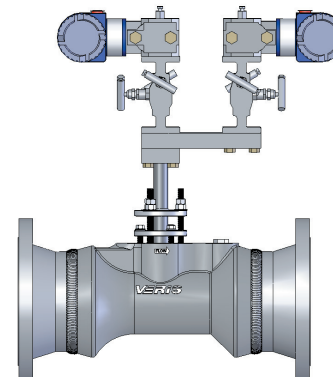

**Dual Transmitter**

## Installation Orientation

### Direct Mount

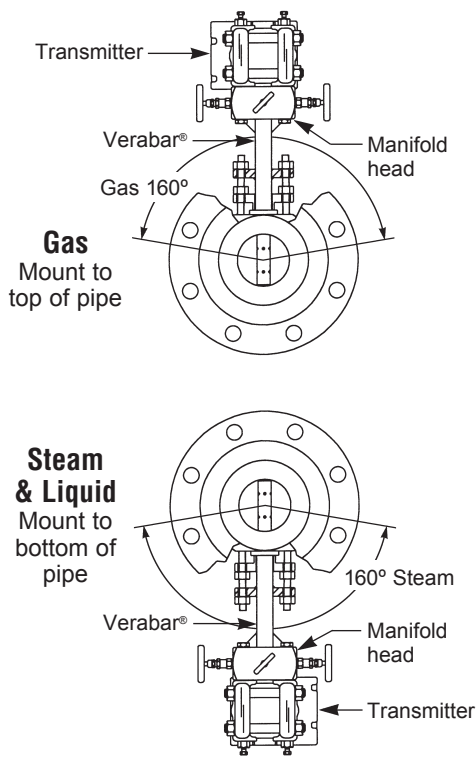

### Remote Mount

